

# 电源电路

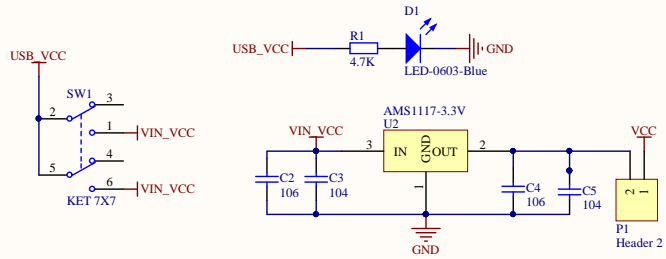

# MCU

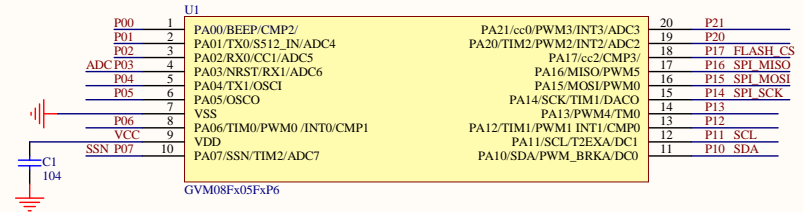

# 串口下载以及通信

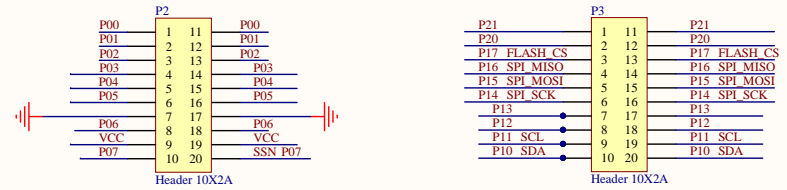
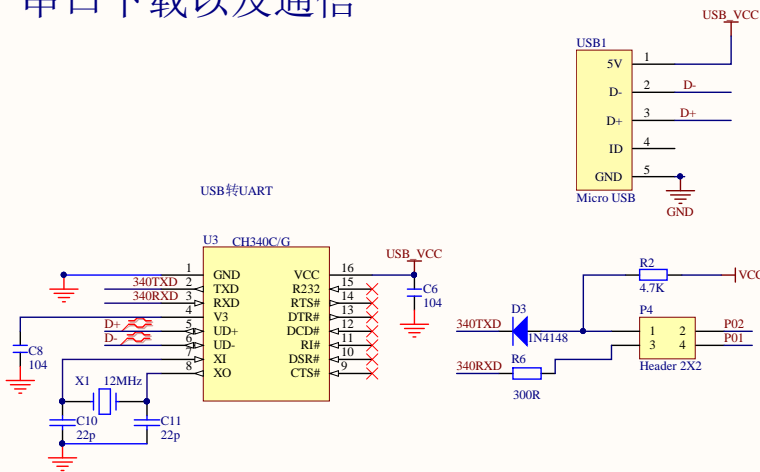

# 外部晶振

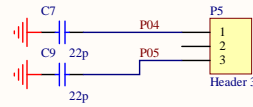

# ADC

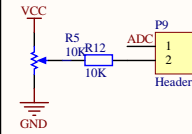

# 按键

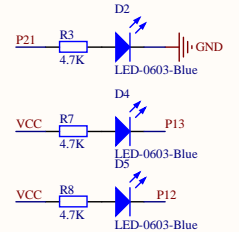
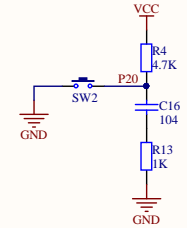

# 温湿度采集

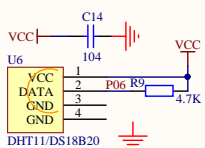

# I2C通信

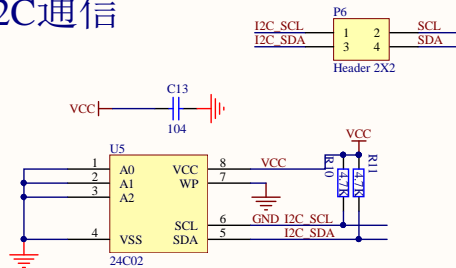

# SPI通信

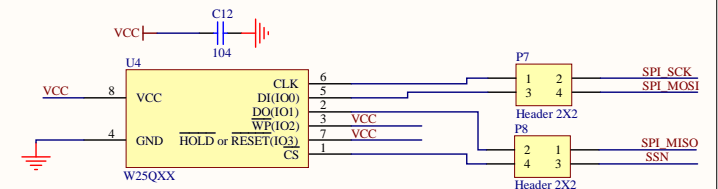

# Board Stack Report